



Airbus 321 Freighter

Operated by White Airways



Tailored air cargo solutions

Global reach, hassle-free delivery:
experience the power of our reliable cargo transportation services

Welcome to Stellavia, where we redefine air cargo transportation with our commitment to excellence, flexibility, and reliability. As a global provider in the air cargo industry, we offer a wide array of transportation services designed to meet the unique needs of our clients. Whether you're moving time-sensitive medical supplies, high-value goods, perishable items, automotive parts, or e-commerce shipments, our fleet and team are equipped to deliver your cargo safely and on time, anywhere in the world. Our services are tailored to provide the utmost in convenience and efficiency. We offer flexible scheduling options, including fixed and adjustable shipment dates, to accommodate your business demands. With a deep understanding of the complexities of cargo logistics, we handle every shipment with precision and care, adhering to the highest industry standards, including IATA and EASA regulations.

Efficient and Reliable:
Stellavia's A321F for Diverse Cargo Needs.

Stellavia proudly offers top-tier cargo **charter and ACMI** solutions with our state-of-the-art Airbus A321F. Designed for efficiency and reliability, the A321F is the ideal choice for diverse freight needs.

History of Conversion

Our A321F has been developed through a collaboration between **Precision Aircraft Solutions** and **Avocet Aviation Services**, two companies with extensive experience in aircraft conversions since 2017. The journey began with their first A321 conversion, which took two years of meticulous engineering and design. This initial model was ultimately approved, marking the beginning of continuous improvements and advancements in the aircraft.

Five years after the approval of their first conversion, Stellavia is now ready to showcase this aircraft to the world.



The A321-200PCF Freighter, developed through this collaboration, comes with the EASA SB A321PCF-31-001 certification, making it ready to establish its base in Portugal.

This freighter features **the highest revenue payload and a design meticulously** tailored to meet customer needs.

Equipped with the versatile TELAIR main deck cargo loading system and a lower lobe that supports bulk, sliding carpet, or containerized systems, the A321-200PCF Freighter offers unparalleled flexibility in cargo capacity.

This freighter boasts the lightest airframe in its class, with an Operating Empty Weight (OEW) exceeding 1360 kg less than its nearest competitor. The design focuses on freight operations, optimizing revenue loads, profitability, capacity for additional personnel, and fuel efficiency.

Key Features

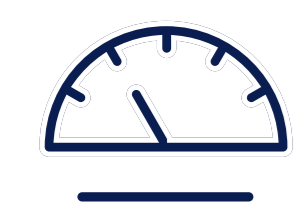

Lowest Operating Empty Weight (OEW):

The lightest A321-200 freighter conversion available, resulting in a reduced carbon footprint.

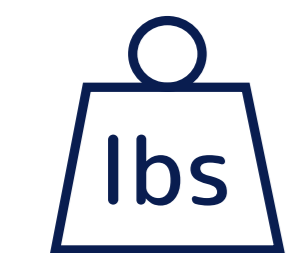

Payload Capacity:

Approx. 27,000 kg (WV 000), with no OEM weight upgrade prerequisites.

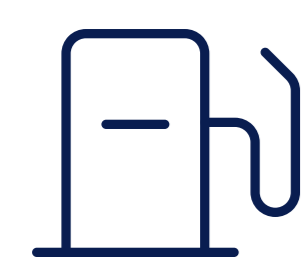

Fuel Consumption:

Around 2,800 kg per hour at max payload (27 tons)



Occupant Capacity:

Accommodates 4 + 2 crew members.



Crew Amenities:

Includes a crew galley with baggage storage and a full-size lavatory.



Door Configuration:

Retains full-size L1/R1 doors.

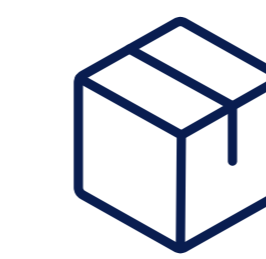

Cargo Volume:

226 m³, offering 39 m³ more than the B737-800F.



Structural Payload:

Highest standard structural payload for greater flexibility and higher profitability.



Unique Additional Features:

- ✓ **Enhanced Flight Deck:** Larger flight deck equipped with crew service and lavatory.
- ✓ **Operational Efficiency:** Lower OEW leads to reduced fuel consumption and increased revenue potential.
- ✓ **Loading Flexibility:** 14 ULDs in Main Deck, 10 in Lower Deck
- ✓ **Advanced Loading Options:** Dual locks for PAG netted pallets or 2 AKH's at the 14th position.
- ✓ **Structural Design:** No permanent ballast added, improved center of gravity (CG).
- ✓ **Total Volume:** 226 cubic meters (7,963 Cu. Ft.).
- ✓ **Containerized Volume:** 208 cubic meters.
- ✓ **Cutting-Edge Cargo Technology:** Main deck is equipped with Telair cargo handling system, Telair composite floor panels with integral non-slip surface, reinforced floor beams and OEM lower frames, TSO certified optical detectors, fully recessed LED lighting and smoke detectors.

Specification Sheet

Aircraft Description

Type:Model/Series	A321-232
Date of Manufacture:	7-Nov-2002
Serial Number:	1675
Fleet Serial Number:	004
Weight Variant:	WV000
Operator:	WHITE AIRWAYS (IATA, EASA, IOSA certified)
Registration number:	CS-MBA (TBC)
Previous Country of Registration:	DENMARK
Engine Type	IAE V2500
Noise Compliance:	ICAO Chapter 4
ETOPS	NO
RVSM	YES
Sharklets	NO
FANS B+	YES
Conversion - PEMCO - ST02716SE	YES

AVOCET Cargo Mod Completion Date: December 15, 2023

Operational Weight

Max Taxi Weight	197,093	lbs	89,400	kg
Max Takeoff Weight	196,211	lbs	89,000	kg
Max Landing Weight	166,448	lbs	75,500	kg
Max Zero Fuel	157,630	lbs	71,500	kg
Empty Weight	98,106	lbs	44,500	kg
Total Fuel Capacity	52,250	lbs	23,700	kg

Inspection Status

Maintenance Program (Airbus MPD) Last C-ck: tasks completed during cargo mod (see LDND)

Completion Date: 15-Dec-2023

Landing Gear Status	P/N	S/N	CSO	OVH Date	Removal Due Date
Left Main Gear	201659001	MDL1675	6	17-Feb-2022	15-Feb-2032
Right Main Gear	201659002	MDL1675	6	17-Feb-2022	15-Feb-2032
Nose Gear	D23589520-14	B741	6	14-Feb-2022	12-Feb-2032

Engine Status:	S/N	TSN	CSN	TSPR	CSPR
P/N: V2530-A5 Position #1	V11186	38662.73	26663	9936.80	6828

ALL LLP CYCLE LIMITER: 13172

Engine Status:	S/N	TSN	CSN	TSPR	CSPR
P/N: V2530-A5 Position #2	V11319	39629.73	26511	10638.28	7368

ALL LLP CYCLE LIMITER: 12632

APU Status:	S/N	TSN	CSN	TSPR	CSPR
P/N: 3800708-1	R-2505	11427.15	41389	13.15	29

ALL LLP CYCLE LIMITER: 29971

Cargo Compartments

Typical A-Code Payload Arrangement in Main Deck

14 Pallets – Main Deck

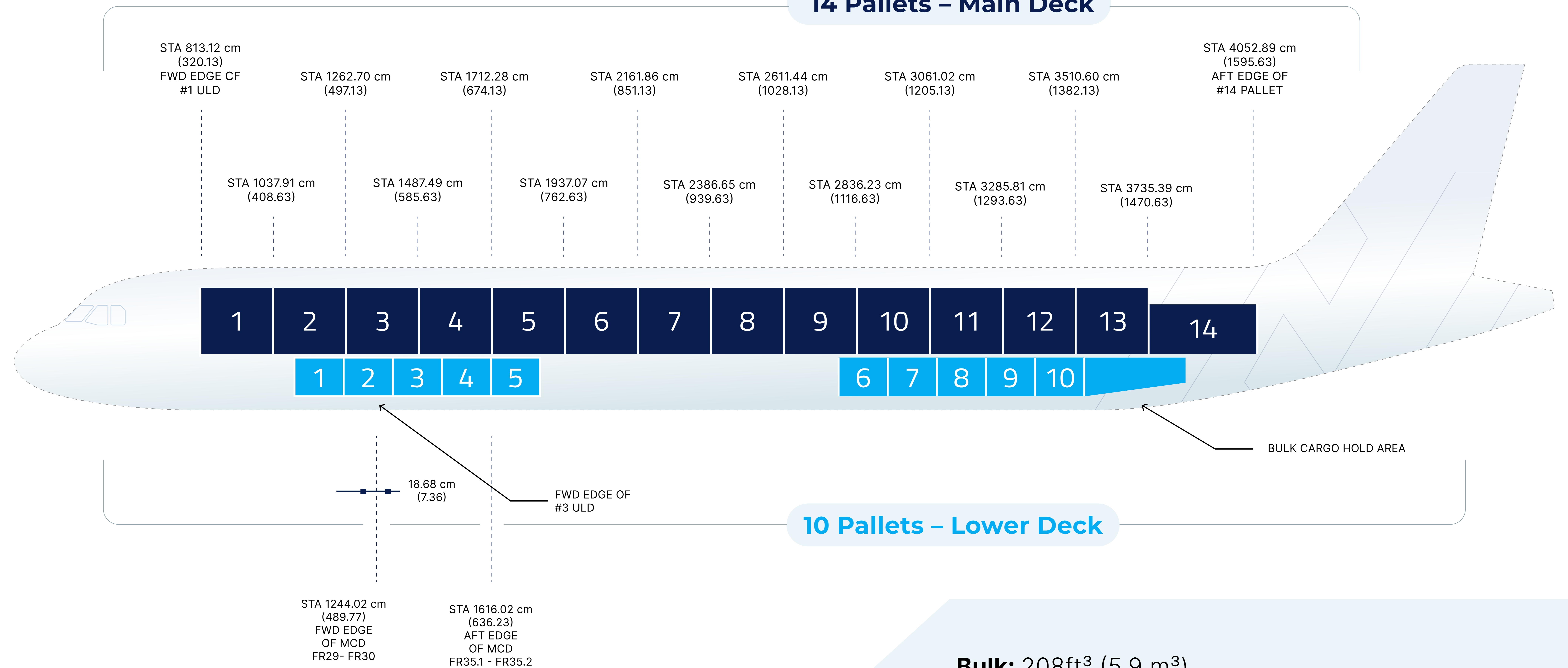

10 Pallets – Lower Deck

Bulk: 208ft³ (5.9 m³)

* in favour of containerized ULD, water volume, no bulk

ULD Configuration and Cargo Capacity

Main deck

- 14 pos. 88" x 125" x 82" (AAY, PAG/PAJ)
- Max. height 82"
- **Main Deck Cargo Door (MDCD)**
MDCD Structural Width 3733.8 mm (147 in)
Width between entrance guides 3510.8 mm (138.2 in)
Clear Height 2152.7 mm (84.8 in)

Lower deck

- 10 pos. 60" x 61" x 45" (AKH, PKC)
- Max. height 45"
- **Forward- and Aft compartment door:**
(H x W): 46" x 71"
- **Compartment 5:** Loose cargo only
- **Bulk compartment door** (H x W): 30" x 36"

Loading height

- **Main deck:** Max. 82"
- **Lower deck:** Max. 45"

Cargo capacity

- 27,000 kg (61,729 lbs)



ULD Specification and buildup contour

PAG

UNIT LOAD DEVICE

CLASSIFICATION:
PAG, PAA, PAJ, PAP

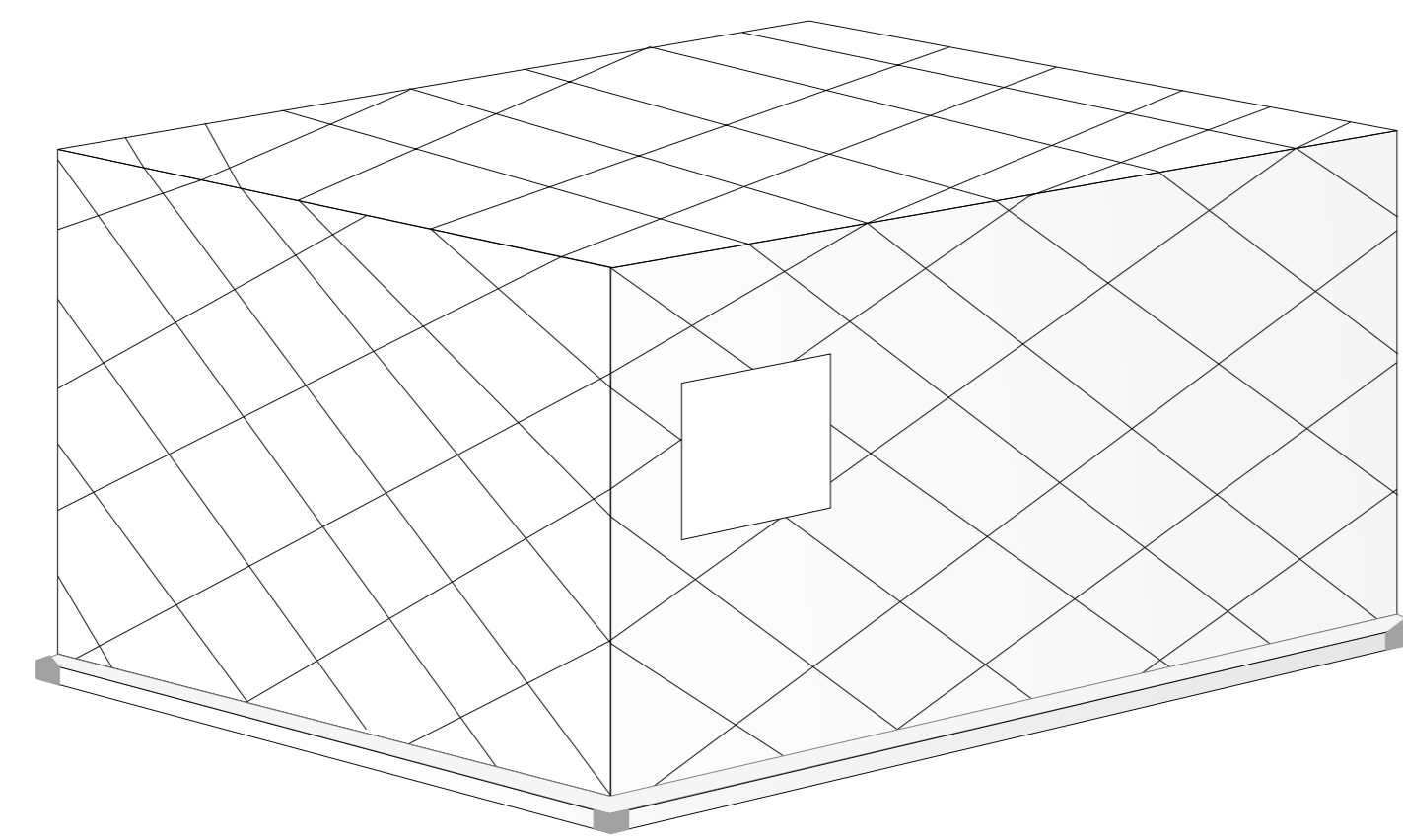

Dimensions

- **Length** 318cm | 125in
- **Width** 224cm | 88in
- **Height** 163cm | 64in Top N/A
- **Nominal Capacity and Weight**
- **Usable Volume** 10.85m³ | 383ft³

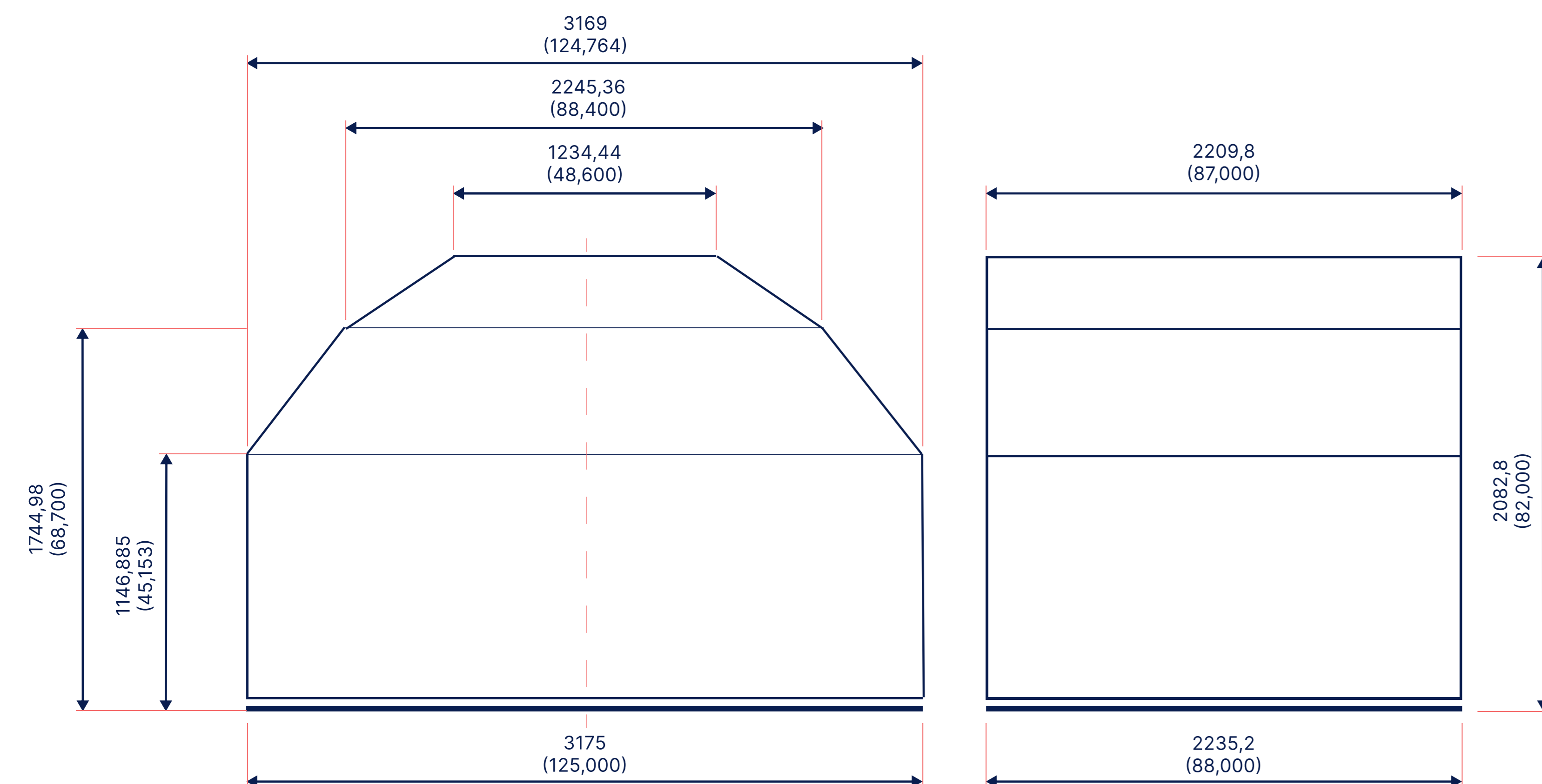

AKH

UNIT LOAD DEVICE

CLASSIFICATION:
AKH, LD3-45

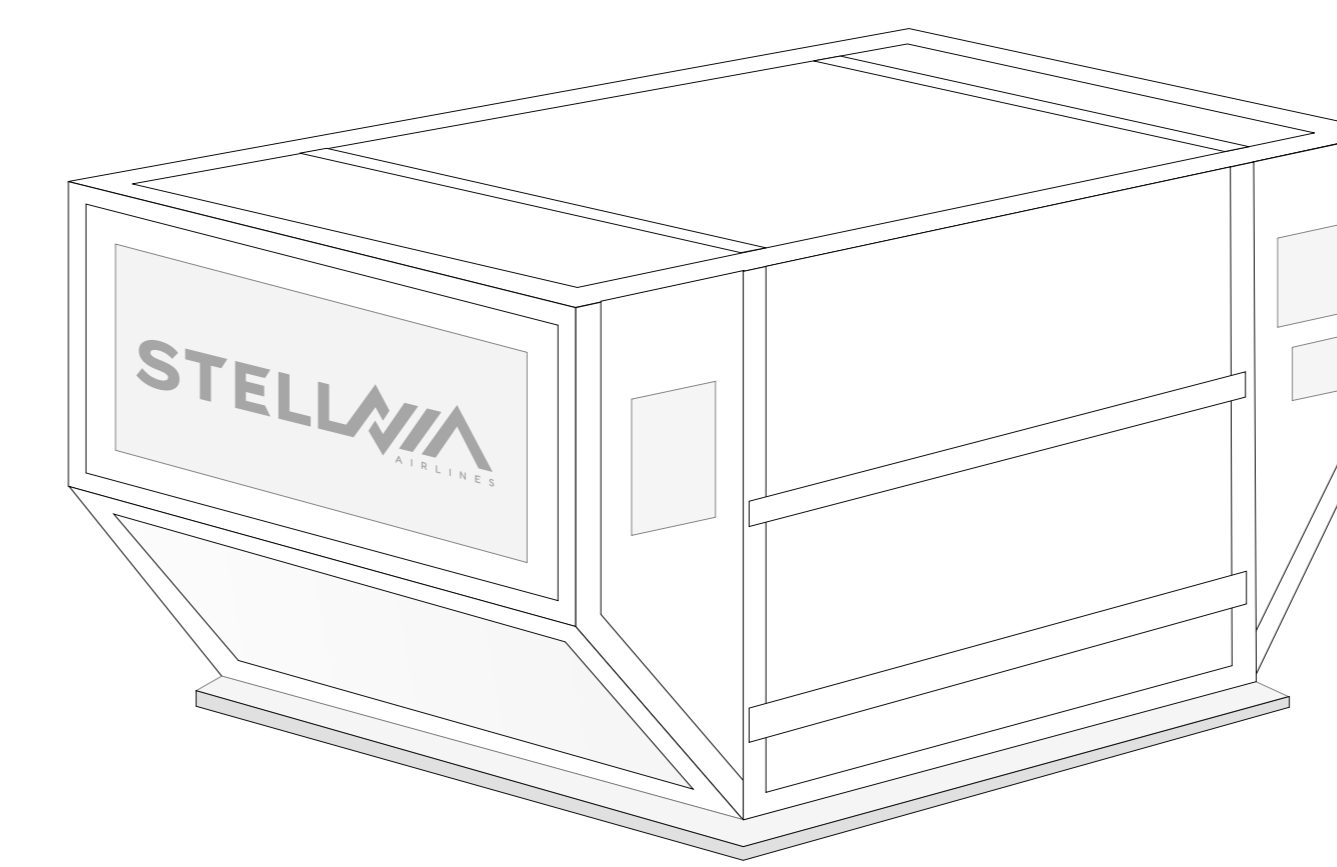

Dimensions

- **Length** 156cm | 61.5in
- **Width** 153cm | 60.4in
- **Height** 114cm | 45in Top 244cm | 96in
- **Nominal Capacity and Weight**
- **Usable Volume** 3.7m³ | 131ft³
- **Maximum Gross Weight** 1588kg | 3500lbs

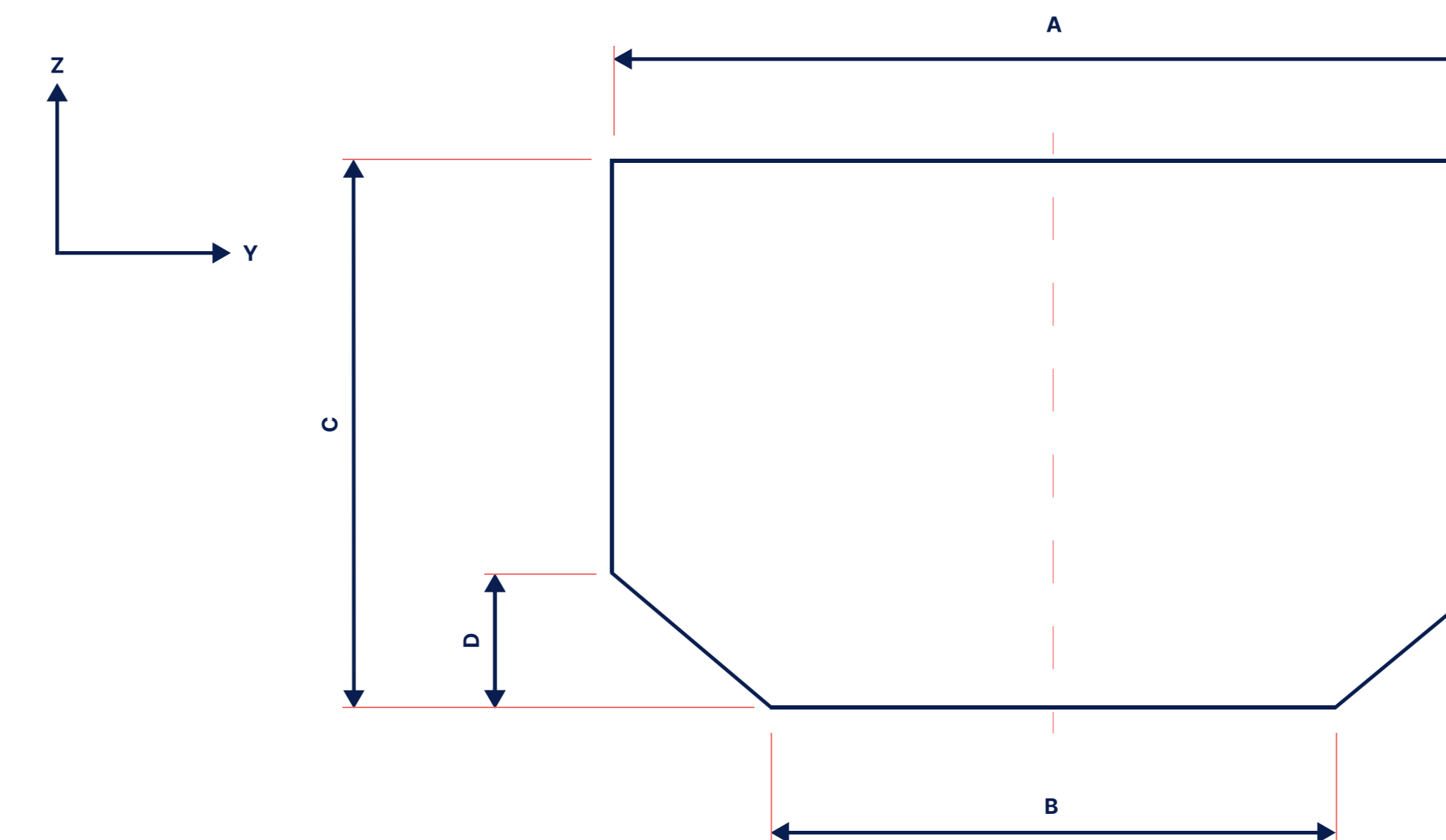

Legend	(m)	(in)
A	2,451	96,50
B	1,562	61,50
C	1,143	45,00
D	0,498	19,60



Key Benefits and advantages

 **Versatile
Capacity**

Supports various cargo types, from perishables to oversized goods.

 **Eco-Friendly
Operations**

Fuel-efficient with sustainable operational practices, minimized environmental impact.

 **Optimal
Payload**

Payload of up to 27 metric tons and a volume of 208 cubic meters, the A321F offers an excellent balance between cargo volume and weight.

 **Advanced
Technology**





Equipped with modern avionics and systems, the A321F ensures more efficient flight operations and route planning.

 **Operational
Efficiency**

Optimized routes and load planning for swift and safe deliveries, ability to operate from a wide range of airports opens up cost-effective routing options.

Why Choose



-  **Modern Fleet:** cutting-edge Airbus A321F, designed for maximum efficiency and reliability in cargo transport.
-  **Customized Services:** Tailored solutions for specific industries, ensuring seamless logistics.
-  **Dedicated Support:** 24/7 customer service for real-time assistance and updates.
-  **Safety and Compliance:** Stringent adherence to international aviation regulations and best safety practices.
-  **Cost Efficiency:** We offer competitive rates without compromising on quality or service.
-  **Global Reach:** Access to a broad network of destinations, ensuring global reach and timely deliveries.



Contact Us

We're here to assist you with all your air cargo transportation needs. Contact us today!

 **Phone:** +351 308 815 288

 **Email:** sales@stella-via.aero

Your Cargo, Our Commitment!